



Set Up Guide & User Manual

**Hearing Helper[®] PERSONAL FM System
Models PFM 300 & PFM 350**

Wireless FM Listening System

Transmitter Model T30
Receiver Models R31, R32

 **Williams Sound[®]**
Helping People Hear



HEARING HELPER® PERSONAL FM SYSTEM, MODELS PFM 300 / PFM 350 INSTALLATION GUIDE & USER MANUAL

Contents	Page
SYSTEM OVERVIEW	4
SYSTEM COMPONENTS	5
USING THE T30 TRANSMITTER	6
USING THE PFM R32 RECEIVER	7
USING THE PFM R31 RECEIVER	8
BATTERY INFORMATION	10
USING YOUR PERSONAL FM SYSTEM WITH A HEARING AID	12
APPLICATIONS FOR VARIOUS HEARING LOSS LEVELS	13
IN CASE OF DIFFICULTY	14
CHANGING FREQUENCIES	15
WARRANTY	17
SYSTEM SPECIFICATIONS	18
ACOUSTIC SPECIFICATIONS	19

SYSTEM OVERVIEW

Thank you for purchasing the Hearing Helper® Personal FM System from Williams Sound Corp. Anyone needing auditory assistance to overcome background noise, reverberation, or distance from the sound source can benefit from the Personal FM System.

Your PFM System has two principal parts: the Transmitter and the Receiver. Much like a miniature radio station, the Transmitter and microphone pick up the sounds you want to hear and broadcast them over an FM radio signal. The receiver and earphone are used to pick up the broadcast up to 100 feet away.

To avoid difficulties, please read through these instructions as you begin to use the system. Then save them for questions that arise as you continue to use your Williams Sound Personal FM System.

If you have problems with the PFM system, don't hesitate to call us toll-free at 1-800-843-3544.

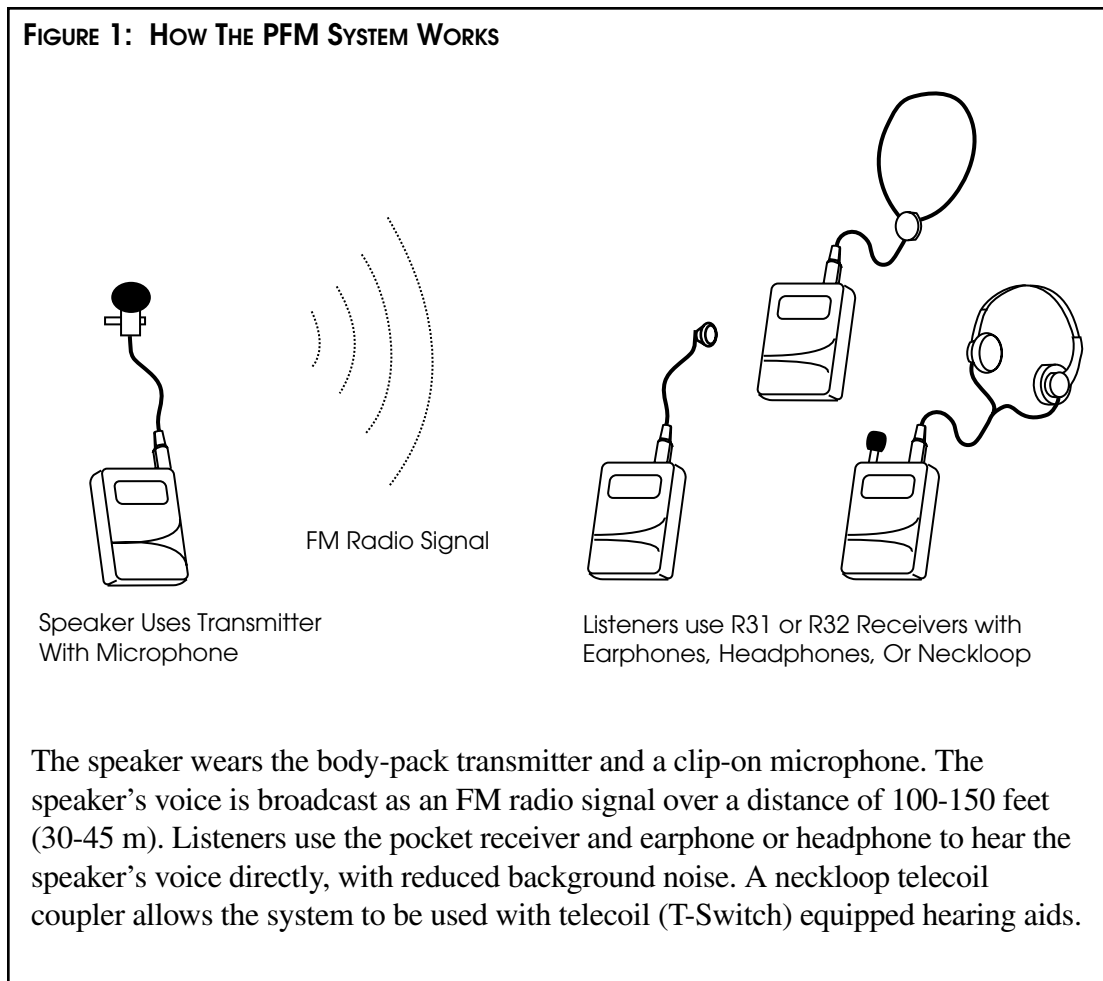

SYSTEM COMPONENTS

- ▶ Body Pack Transmitter (PFM T30) with (2) AA batteries (BAT 001)
- ▶ Lavalier microphone (MIC 090)
- ▶ Mini earphone (EAR 013)
- ▶ Soft Nylon System Carry Case (CCS 020)
- ▶ (2) Belt clip cases (CCS 021)
- ▶ Instructions (MAN 072)
- ▶ PFM System 300 Only:
Personal FM Receiver (PFM R32) with (2) AA batteries (BAT 001)
- ▶ PFM System 350 Only:
Personal FM Receiver (PFM R31) with Plug Mount Microphone (MIC 014)
and (2) AA batteries (BAT 001)

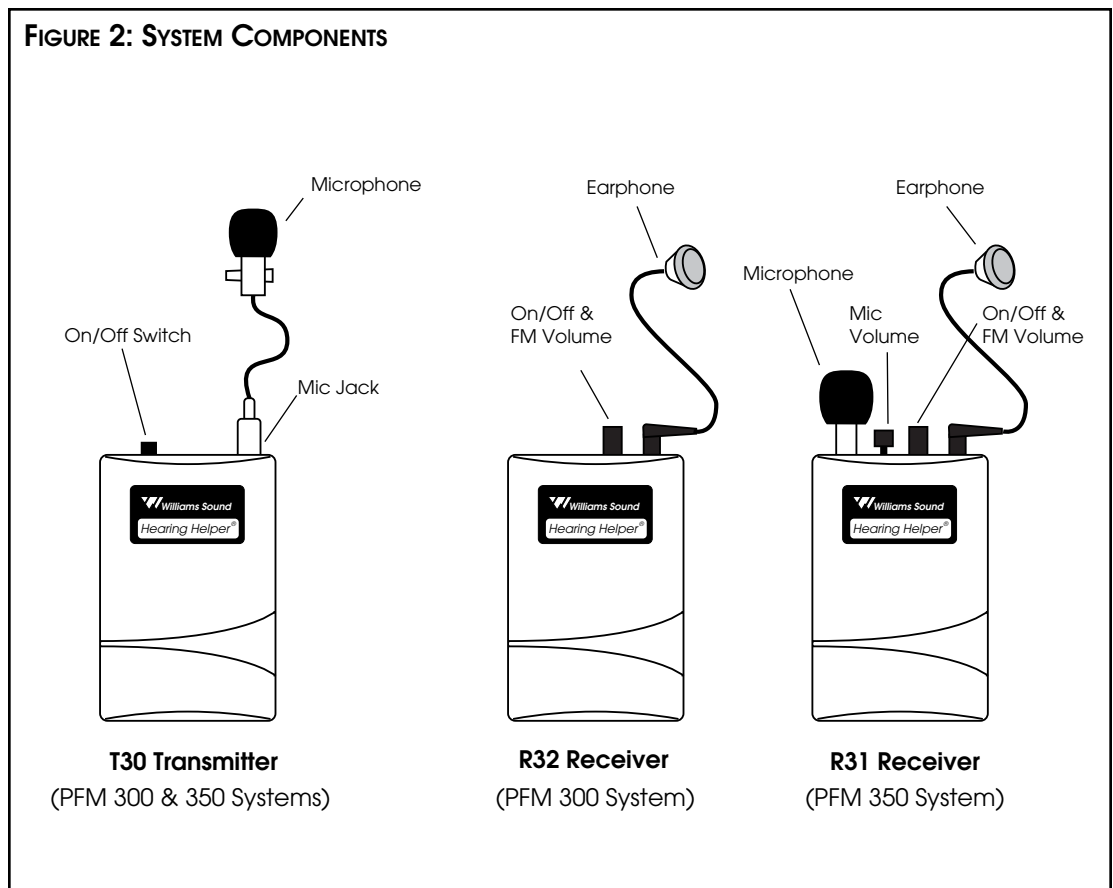

USING THE T30 TRANSMITTER

1. Make sure there are two charged AA batteries in the transmitter. If batteries are not installed, see *Battery Information* on page 10.
2. Plug the microphone cord into the “Mic” jack on top of the Transmitter.

FIG. 3: T30 TRANSMITTER TOP VIEW

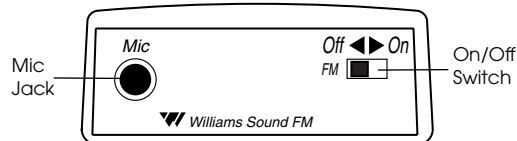

3. Place the Transmitter in the belt clip case provided.
4. Turn the power switch on top of the Transmitter to “On.”
5. Clip the microphone onto a collar, lapel, or tie. It should be as close to the speaker’s mouth as is practical. (See Figure 4.)

The transmitter can be placed in a pants pocket, or clipped onto a belt or waistband. Make sure the Transmitter is turned OFF when not in use.

FIGURE 4: CORRECT MICROPHONE PLACEMENT

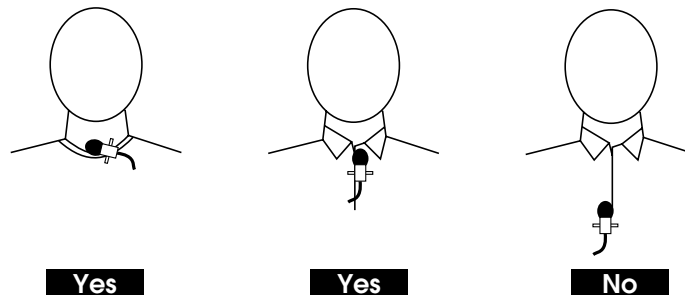

The PFM System 300/350 comes with an omnidirectional, lapel-clip style microphone. It should be clipped to a collar, lapel, tie, or neckline as close to the mouth as possible and centered on the body as shown.

Note On The Transmitter Antenna:

The microphone cord is the transmitting antenna. Do not bunch up the cord or wrap it around the transmitter. For maximum range, the cord should hang as straight as possible.

USING THE PFM R32 RECEIVER (PFM 300):

Receiver model PFM R32 has a single volume control and an earphone output jack.

1. Make sure there are two charged AA batteries in the Receiver. If batteries are not installed, see *Battery Information* on page 10.
2. Plug the earphone or headphone into the “Ear” jack on top of the Receiver.

FIGURE 5: R32 RECEIVER TOP VIEW

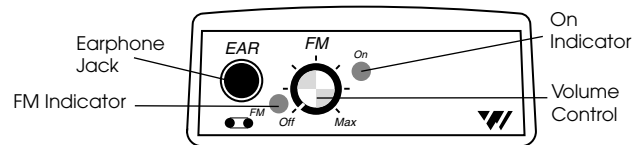

3. Turn the power on by rotating the volume control knob on top of the Receiver.
4. Place the earphone in your ear.
5. Choose the correct channel using the right switch on the R32's back panel. Unless you have changed the Transmitter channel, set the receiver to channel 1. If the Transmitter is on and tuned to channel 1, the FM Indicator light on the R32 will light.

FIGURE 6: RECEIVER TONE & CHANNEL CONTROLS

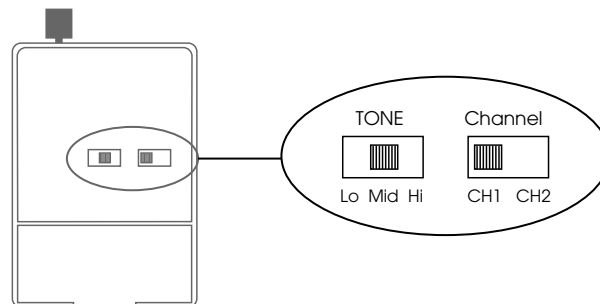

6. Adjust the receiver volume control to a comfortable listening level. You should be able to hear someone speaking into the Transmitter microphone.
7. Adjust the receiver tone control to your needs. Lo – more low frequencies; Mid – some low frequency cut; Hi – maximum low frequency cut, emphasizes higher frequencies. (See Figure 6.)
8. Place the Receiver in the belt clip case provided. The Receiver can be placed in a pants pocket, or clipped onto a belt, harness, or waistband.

Notes:

The earphone cord is the receiving antenna. Do not bunch up the cord or wrap it around the receiver. For best reception, the cord should hang as straight as possible. Make sure the Receiver is turned OFF when not in use. The channel selector can be used to switch between an individual and a group channel.

USING THE PFM R31 RECEIVER (PFM 350):

Receiver model PFM R31 has two volume control knobs (one for the FM signal, one for environmental sounds), a microphone input jack, and an earphone output jack.

1. Make sure there are two charged AA batteries in the Receiver. If batteries are not installed, see *Battery Information* on page 10.
2. Insert the small Plug Mount Microphone (MIC 014) into the “Mic” jack on top of the R31 Receiver.

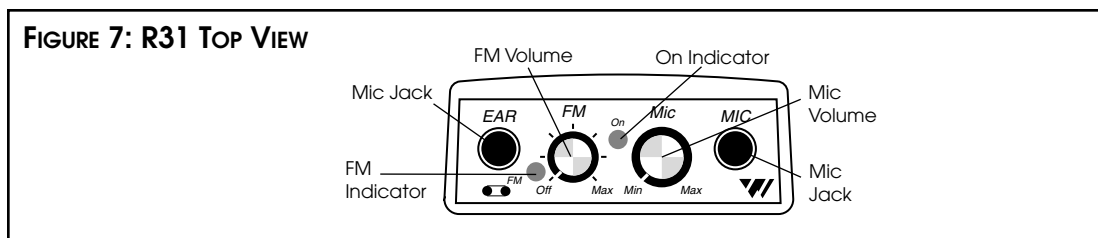

3. Plug the earphone or headphone into the “Ear” jack on top of the Receiver.
4. Turn the power on by rotating the taller “FM” volume control on top of the Receiver.
5. Place the earphone in your ear.

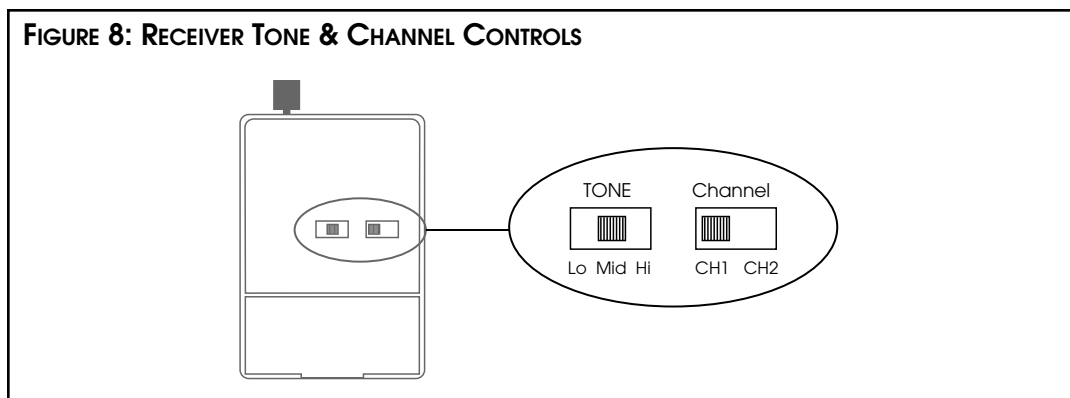

6. Choose the correct channel using the right switch on the R31’s back panel. If the Transmitter is on and tuned to channel 1, the FM Indicator light on the R31 will light.
7. Adjust the receiver tone control to your needs. Lo – more low frequencies; Mid – some low frequency cut; Hi – maximum low frequency cut, emphasizes higher frequencies. (See Figure 6.)
8. Place the Receiver in the belt clip case provided. The Receiver can be placed in a pants pocket, or clipped onto a belt, harness, or waistband.



Notes:

The earphone cord is the receiving antenna. Do not bunch up the cord or wrap it around the receiver. For best reception, the cord should hang as straight as possible. Make sure the Receiver is turned OFF when not in use. The channel selector can be used to switch between an individual and a group channel.

Adjusting The R31 Volume Controls

1. Adjust the taller “FM” volume control to a comfortable listening level. You should be able to hear someone speaking into the Transmitter microphone.
2. Now adjust the shorter “Mic” volume control until you can hear sounds picked up by the environmental microphone on top of the receiver.
3. Adjust the two volume controls for a comfortable mix of FM and environmental sounds.

You will normally want to have the FM signal louder than the environmental Mic signal to avoid picking up extra background noise. If no environmental sounds are desired, turn the “Mic” control fully to “Min”. If you want to hear nearby conversation or your own voice, turn the “Mic” control up.

BATTERY INFORMATION

INSTALLATION

Open the battery compartment using a coin in the slot in the bottom of the receiver. Press the batteries into place, observing proper battery polarity. Incorrect insertion of the battery is difficult, and may cause both mechanical and electrical damage to transmitters or receivers not covered by the 5 year warranty. Units will not work with the battery incorrectly installed.

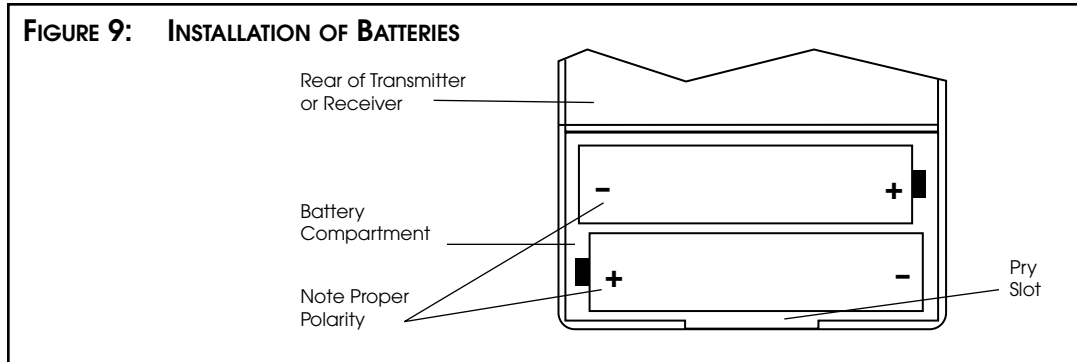

DISPOSABLE BATTERIES

In normal use, two AA 1.5 V alkaline batteries will last about 12 hours in the T30 Transmitter and approximately 80 hours in the R31 and R32 Receivers, respectively.

If the sound becomes weak or distorted, replace the battery. The indicator light may still be on, even with a battery that is weak. Do not leave dead batteries in the receivers. Battery corrosion is not covered by the Williams Sound five year warranty.

RECHARGEABLE BATTERIES

The PFM 300 and PFM 350 Systems can use rechargeable AA batteries (BAT 026). On an overnight charge, these NiMH batteries are designed to operate a T30 Transmitter for approximately 10 hours, and R31 and R32 Receivers for 50 and 60 hours, respectively.

The battery installed in the receiver may be recharged in the receiver only if it is a Nickel Cadmium battery, and only if the Williams Sound CHG 200A charger is used. Damage from improper charging is not covered by the Williams Sound five year warranty. For charging directions, see figure 9.

!! IMPORTANT WARNINGS !!

DO NOT ATTEMPT TO RECHARGE ZINC CARBON ("HEAVY DUTY"), ALKALINE, OR LITHIUM BATTERIES!

DO NOT ATTEMPT TO RECHARGE DISPOSABLE BATTERIES! These batteries may heat up and explode, causing possible injury and damage to the equipment.

Avoid shorting the plus and minus battery terminals together with metal objects. Battery damage and burns can result!

Use only Williams Sound Supplied chargers and batteries!

FIGURE 10: USING THE OPTIONAL CHG 200A BATTERY CHARGER TO CHARGE TRANSMITTERS AND RECEIVERS

- Step 1: Plug the CHG 200's power supply into the Power Input on the charger's side and a standard AC wall outlet.
- Step 2: Route the power cord around the Cord Hook (see figure at right). This will minimize strain on the cord and jack and insure that the power cord is not detached during charging.
- Step 3: Make sure the receivers/transmitters to be charged are turned OFF.
- Step 4: Place the receivers/transmitters in the slots so that the CHG 200's Charging Pins and receiver's side panel contacts are coupled. Make sure that the charging contact holes line up with the charging pins. The receivers should drop easily into the slots. **DO NOT FORCE THEM IN BACKWARDS.**
- Step 5: The Charging Indicators will light, indicating that charging is in process.
- It takes 14–16 hours to fully charge the batteries. Remove the receivers when charging is completed.

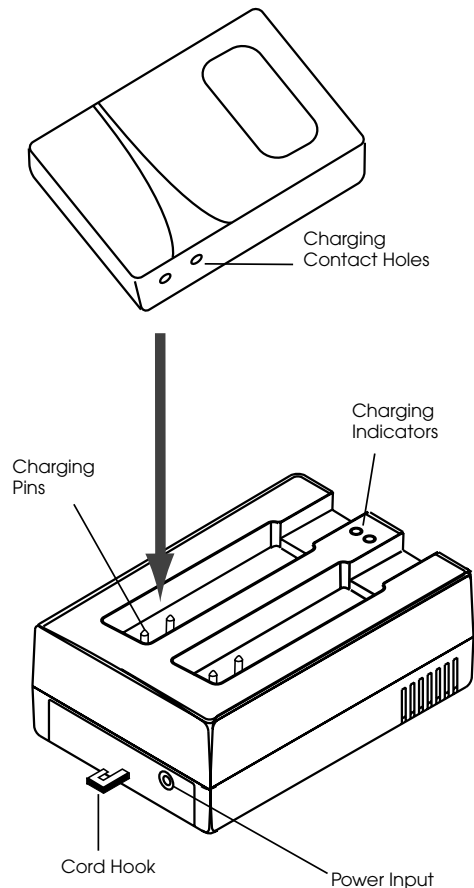

FURTHER SUGGESTIONS

Receivers and Transmitters **SHOULD NOT** be left charging continuously when not in use. Receivers should always be turned OFF while charging.

It's best to allow the batteries to fully discharge before charging.

If the batteries are near end of life and the LED turns off while the receiver is operating, this is an indication to change or recharge your batteries. Approximately one hour of battery life remains.

Repeatedly charging the batteries after short periods of use (1-2 hours) will shorten battery life.

Rechargeable batteries will need to be replaced after 1–2 years of use.

!! WARNING !!
DO NOT ATTEMPT TO RECHARGE DISPOSABLE BATTERIES!

The batteries may heat up and burst, causing possible injury and damage to the equipment.

Avoid shorting the plus and minus battery terminals together with metal objects. Battery damage and burns can result!

Use only Williams Sound supplied chargers and batteries.



USING YOUR PERSONAL FM SYSTEM WITH A HEARING AID

If you have a hearing aid equipped with a Telecoil (T-Switch), you can use a Neckloop (NKL 003—children’s size, or NKL 001—adult’s size) or Silhouette coil (INC 005 WC) to magnetically couple the signal from the PFM Receiver into your hearing aid.

The Neckloop plugs into the earphone jack of the receiver. Turn the switch to the “T” position on your hearing aid and adjust the volume control on the receiver to a comfortable level. If you have two hearing aids with telecoils, the signal will couple into both hearing aids (when using INC 006 WC).

Direct Audio Input cords can be used with compatible hearing aids as well as with Cochlear Implant Processors. If your hearing aid has a direct audio input boot, you can obtain a cord from your hearing aid manufacturer to plug directly into the PFM receiver. The cord should have a 3.5 mm plug.



APPLICATIONS FOR VARIOUS HEARING LOSS LEVELS

The Personal FM is designed to provide hearing assistance for anyone when background noise or distance from the sound source make listening difficult. The microphone and transmitter are placed close to the desired sound source to help minimize background noise and to effectively eliminate the distance between the listener and the sound source. Because hearing ability varies, three categories of amplification have been delineated:

NO HEARING LOSS – LOW AMPLIFICATION

Among Low Amplification applications are classroom and similar uses. The PFM System can be used with headphones or earphones for Central Auditory Processing Disorders, Learning Disabilities, or Attention Deficit Disorders. The PFM System is used primarily to boost speech sounds above other background noises, making it easier for the listener to focus on what is being said. The optional Rugged Headphone (HED 022–children’s size, and HED 021–adult’s size) are recommended for this application. The EAR 013 Single Mini Earphone, EAR 008 Surround Earphone, or EAR 014 Dual Mini Earphone can also be used.

MILD – MODERATE HEARING LOSS

These applications include the classroom, TV listening, car riding, and one-on-one conversations. The PFM System can be used with the Single or Dual Mini Earphone (EAR 013 or EAR 014) for moderate amplification fittings. The Button Receiver Earphone (EAR 012 WC) is also available for use with a snap-on custom earmold. The PFM System is also suitable for temporary mild hearing loss due to Otitis Media. The Rugged Headphones (HED 021) or Surround Earphone (EAR 022 or EAR 008) are recommended since they do not enter the ear canal.

SEVERE – PROFOUND HEARING LOSS

These applications include the classroom, TV listening, car riding, and one-on-one conversations. For severe to profound hearing loss, the PERSONAL FM System should be used in conjunction with a hearing aid. A Neckloop can be used with hearing aids that have a telecoil. An adaptor cord can be used with hearing aids that have direct audio input.

IN CASE OF DIFFICULTY

If your Personal FM System is not working, check the following:

1. Make sure the batteries are fresh or completely charged and that the “plus” and “minus” terminals are installed correctly.
2. If the rechargeable batteries will only work for a short period of time (less than 1 hour) even after they are fully charged, they must be regenerated. Leave them in the receiver or transmitter with the unit turned on, for 5 - 6 hours. Then turn receiver or transmitter off, place it in the charger, and charge for 14 - 16 hours. This should restore normal battery life. Rechargeable batteries will gradually lose their capacity over time and should be replaced every year.
3. Make sure the microphone is plugged into the T30 Transmitter and the earphone is plugged into the Receiver.
4. If you have the PFM System 350, make sure the R31 Receiver’s plug mount microphone IS NOT plugged into the Transmitter.
5. If you’re using the PFM System 350 with the PFM R31 Receiver, make sure that the earphone has been plugged into the earphone jack and not into the R31 Receiver’s microphone jack.
6. Move the Transmitter and Receiver closer together. You may be out of range. When using the system indoors, it’s normal for the signal to momentarily disappear in certain locations. This is called a “drop-out.” Moving a few feet will restore the signal.
7. Make sure that the Transmitter and Receivers are tuned to the same channel. The units have stickers inside the back cover identifying the channel. Unless the Transmitter channel has been changed, set the Receiver to channel 1.
8. Do not try to use more than one Transmitter on the same channel in close proximity to each other. **MORE THAN ONE TRANSMITTER ON THE SAME CHANNEL WILL RESULT IN INTERFERENCE IF THEY ARE CLOSE TOGETHER.** Keep the systems 50 - 100 feet apart or use separate channels for each system used.
9. If you are still hearing interference on the Receivers, turn the Transmitter off and listen with a receiver. If you hear the interference with the Transmitter off, you need to change to a clear channel. See the re-tuning instructions.
10. If problems remain, contact your dealer for further help. Or call Williams Sound toll-free at 1-800-843-3544.

CHANGING FREQUENCIES

If you experience FM signal interference, you can easily adjust your transmitter and receivers to a use different frequencies. Your first channel choice should be Channel G (75.7 MHz). This matches channel 2 on the R31 and R32 Receivers.

CHANGING THE PFM T30 TRANSMITTER FREQUENCY

1. Open the battery compartment using a coin in the slot in the bottom of the transmitter. Remove the batteries.
2. Lift the flap up and to your left. The back of the Transmitter case will open like a book, exposing the circuit board.
3. Use the diagram in Figure 11 to locate the channel selector switches.

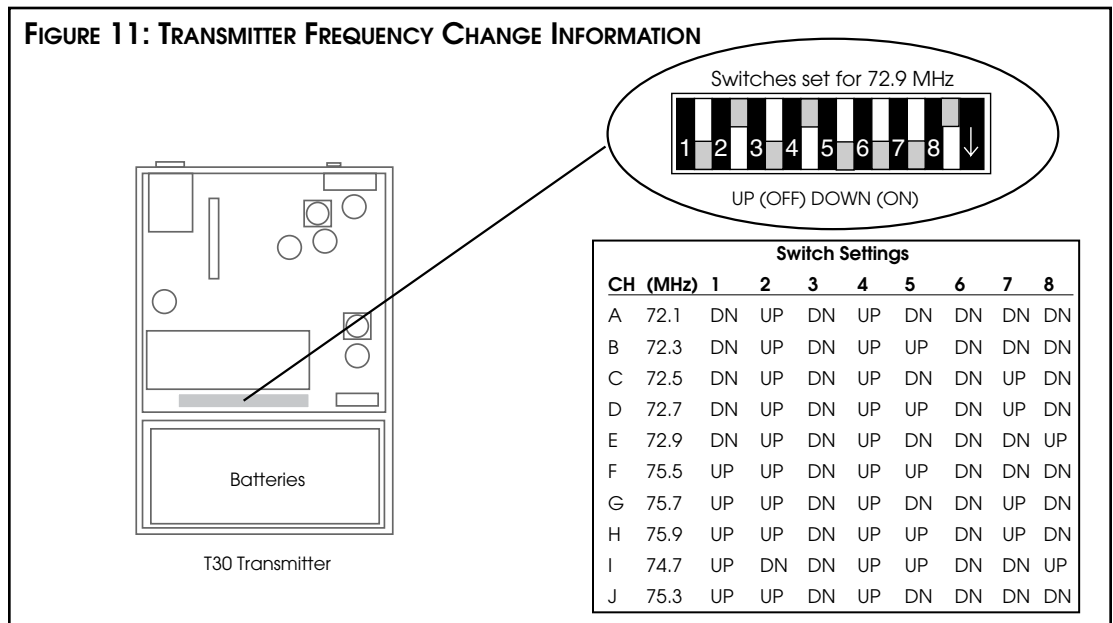

4. Use the tip of a paper clip or a small screwdriver (not a pencil point) to move the switches to correspond with the switch positions on the programming chart in Figure 11. Remember, your first choice should be G (75.7 MHz). If you must use another channel, select a frequency at least two channels away from the one on which you are experiencing interference. Do not touch any other adjustments.
5. Reinstall the batteries, then close the back of the Transmitter.
6. Plug the microphone in and turn the Transmitter on to provide a tuning signal for the receivers.
7. *Change the receivers to channel 2. If you set the transmitter to any channel other than E or G, you will need to re-tune the receivers. See the next section for receiver tuning instructions.*

Note:

Many PFM users reserve Channel 1 on their receivers to match large area FM systems set to Channel E (72.9 MHz). They set their T30 Transmitter to Channel G (75.7 MHz) to allow receiver users to switch between channels depending on the listening situation.

TUNING THE PFM R31 & R32 RECEIVERS

Tuning for the R31 and R32 Receivers is determined by tuning coils, and is stabilized by phase-locked-loop circuitry. A plastic tuning wrench (PLT 005) is needed to adjust the receiver tuning coil.

1. Use the Transmitter as a tuning signal source. Have someone speak into the microphone so you have something to listen to.
2. Keep the Transmitter and Receiver about 15 - 20 feet apart while tuning. The receiver must be tuned under weak signal conditions.
3. Open the battery compartment using a coin in the slot in the bottom of the transmitter. Pull up the receiver battery flap to open the receiver back like a book. This will expose the circuit board.
4. Move the channel selector switch to channel 2 (right position).
5. Use Figure 12 below to locate the tuning coils. Use the earphone supplied with the receiver to listen for the transmitter signal while you slowly and gently rotate the tuning slugs inside the tuning coil with the tuning wrench. Adjust the tuning coil for channel 2 slowly and carefully. Do not press down on the tuning slug. Adjust for maximum signal.
5. Re-tune all the receivers and mark the new frequency inside the case for future reference.

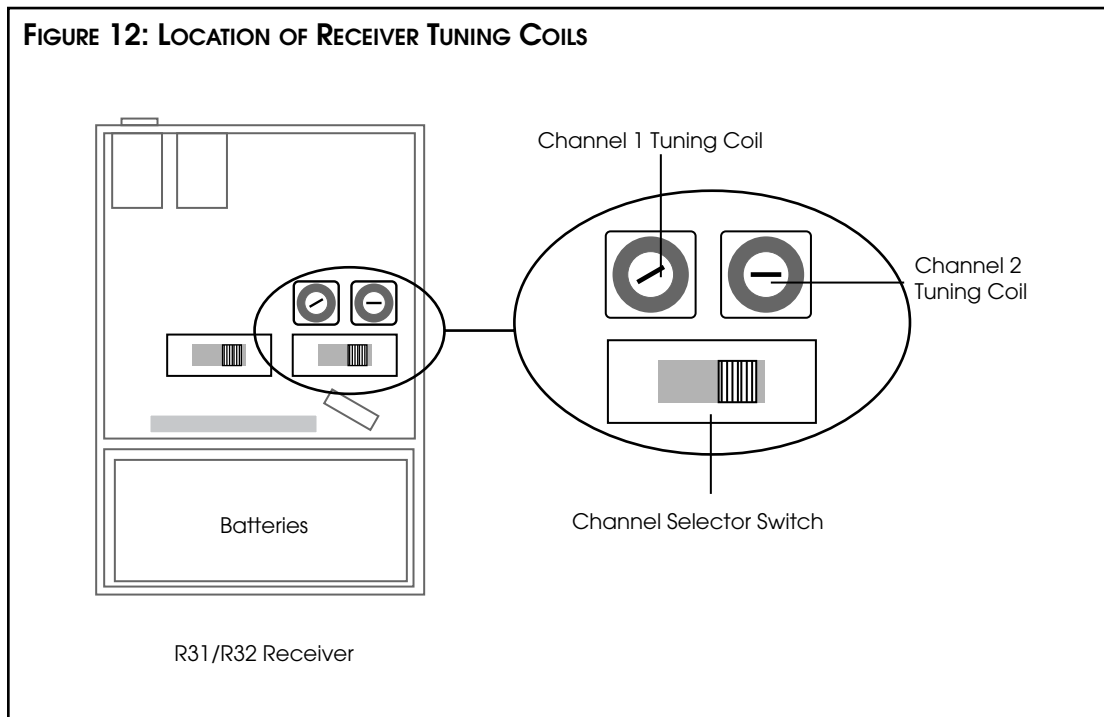



WARRANTY

The Williams Sound T30 Transmitter, R31 and R32 Receivers are engineered and designed to provide you with many years of reliable service. Williams Sound warrants it against defects in materials and workmanship for FIVE (5) years EXCEPT FOR earphones, headphones, rechargeable batteries, chargers, cables, antennas, carry cases, and all other accessory products. Accessory products carry a 90 day warranty.

If the product fails within the specified warranty period, Williams Sound will determine whether to repair or replace the defective equipment. This warranty does not apply to physical damage, products that have been abused or mis-used, or modified.

If you experience difficulty with your system, call Toll-Free for Customer Assistance: 1-800-843-3544.

If it is necessary to return the system for service, your Customer Service Representative will give you a Return Authorization Number (RA) and shipping instructions.

Pack the system carefully and send it to:

Williams Sound Corp.
Attn: Repair Dept.
10321 W. 70th St.
Eden Prairie, MN 55344

Your warranty becomes effective the date you purchase your system. Your returned warranty card is our way of knowing when your warranty begins. It also gives us important information about your system including the serial number. This information will help us serve you better in the future. Please take a moment to complete the warranty card. Thank you.

TECHNICAL SPECIFICATIONS

FM TRANSMITTER, MODEL PFM T30

Dimensions:	3-5/8" L x 2-3/8" W x 7/8" H (92.1 mm x 60.3 mm x 22.2 mm)
Weight:	4.4 oz (125 g) with battery
Color:	Royal blue, shatter-resistant polypropylene
Battery Type:	Two (2) AA 1.5 V Non-rechargeable Alkaline batteries (BAT 001), 70 mA nominal current drain, 12 hours approx. life (OR) Two (2) AA 1.5 V NiMH Rechargeable batteries (BAT 026), 70 mA nominal current drain, 10 hours per charge approx., recharges in 14-16 hours, uses CHG 200 Charger
Operating Freq's:	Selectable, 10 channels, 72.1 – 75.9 MHz, internal DIP switch
Stability:	+ .005%, frequency synthesized, crystal reference, PLL
Modulation:	Wide-band FM, 75 kHz, 75 μ S pre-emphasis
RF Output:	8000 μ V/m at 30 m, max., 40 mW typical
FCC ID:	CNM T30
Freq Response:	100 to 10 kHz, + 3 dB at 1% max. THD
Signal-Noise Ratio:	55 - 60 dB, with R31 or R32 Receiver
Auto Gain Control:	40 dB range, 30 mV threshold
Transmit Antenna:	Integral with 40" microphone cord
Microphone:	Omnidirectional condenser, Lavalier-type, 40" cord, 3.5 mm mono phone plug (MIC 090)
Controls:	On/Off switch, slide-type
Mic Connector:	3.5 mm mono phone jack

RECEIVER, MODELS PFM R31 & PFM R32

Dimensions and Weight:	3-5/8" L x 2-3/8" W x 7/8" H (92.1 mm x 60.3 mm x 22.2 mm) 4.6 oz (130 g) with batteries
Color:	Royal blue, shatter-resistant polypropylene
Battery Type:	Two (2) AA 1.5 V non-rechargeable Alkaline batteries (BAT 001), 14 mA nom. current drain, 80 hours approx. life (OR) Two (2) AA 1.5 V NiMH rechargeable batteries (BAT 026), 14 mA nominal current drain, 50 hours per charge approx., recharges in 14-16 hours, uses CHG 200 Charger
FCC ID:	CNM R31
Operating Freq's:	Pre-Tuned, Field-tuneable, 72 MHz - 76 MHz. Pre-set channels are E (72.9 MHz) and G (75.7 MHz)
FM Deviation:	Wide-band, 75 kHz, 75 μ S de-emphasis
AFC Range:	\pm 120 kHz
Sensitivity:	4 μ V at 12 dB Sinad with squelch defeated, squelches at 10 μ V for min. 50 dB S/N ratio
Freq Response:	100 to 10 kHz, + 3 dB
Signal-Noise Ratio:	50 dB at 10 μ V
Receive Antenna:	Integral with earphone cord
Audio Output:	35 mW, max. at 16 Ω
Output Connector:	3.5 mm mono phone jack
Squelch:	Set to turn off audio under weak or no signal condition
Carrier Detect Ind:	Red LED, turns on in the presence of a carrier
Controls:	Volume: rotary/on/off/volume Tone: 3-way slide switch; Lo = flat response (20 Hz), Mid = -3 dB at 235 Hz, Hi = -3 dB at 730 Hz Channel: 2-way slide switch; Ch 1 = 72.9 MHz, Ch 2 = 75.7 MHz Indicators: On/off and FM
Note:	Specifications are electrical performance

PFM R31 Receiver Only

Mic Connector:	3.5 mm mono phone jack, supplies positive DC for Williams Sound electret mics
Microphone:	Plug mount electret, omnidirectional, with windscreen, 3.5mm mono phone plug (MIC 014)
Mic Volume:	Rotary control

ACOUSTIC SPECIFICATIONS

ANSI 2.44 TEST

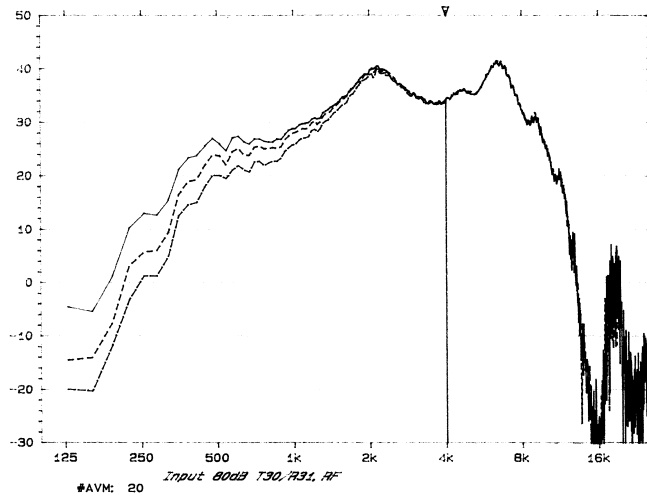

FM Response (PFM R31, R32)

Input: 80 dB random noise
 Device: KEMAR mannequin with BTK 3550 Tester
 Y: 80.0 dB 80 db Main Y: 34.1 dB
 X: 100 Hz + 8 OCT LOG Main X: 4 kHz



Environmental Mic Response (PFM R31 Only)

Input: 80 dB random noise
 Device: KEMAR mannequin with BTK 3550 Tester
 Y: 80.0 dB 80 db Main Y: 50.2 dB
 X: 100 Hz + 8 OCT LOG Main X: 4 kHz

ANSI S3.22-1987 TEST

FM Response (PFM R31, R32)

MINIMUM LOW CUT (TONE SET TO LOW)

Max. SSPL90: 135.8 dB at 500 Hz
 HF Avg SSPL90: 127.1 dB
 HF Avg Full On Gain: 37.7 dB at 60 dB in
 Reference Test Gain: 38.1 dB
 Response Limit: 80.1 dB F1=200 Hz, F2=8 kHz
 Total Harmonic Dist: 3.6 % at 500 Hz
 3.9 % at 800 Hz
 2.2 % at 1600 Hz

MEDIUM LOW CUT (TONE SET TO MID)

Max. SSPL90: 135.5 dB at 600 Hz
 HF Avg SSPL90: 127.1 dB
 HF Avg Full On Gain: 36.8 dB at 60 dB in
 Reference Test Gain: 37.3 dB
 Response Limit: 79.4 dB F1=200 Hz, F2=8 kHz
 Total Harmonic Dist: 3.4 % at 500 Hz
 3.4 % at 800 Hz
 2.2 % at 1600 Hz

MAXIMUM LOW CUT (TONE SET TO HI)

Max. SSPL90: 133.5 dB at 1000 Hz
 HF Avg SSPL90: 127.0 dB
 HF Avg Full On Gain: 35.4 dB at 60 dB in
 Reference Test Gain: 35.8 dB
 Response Limit: 78.01 dB F1=200 Hz, F2=8 kHz
 Total Harmonic Dist: 1.1 % at 500 Hz
 2.7 % at 800 Hz
 2.1 % at 1600 Hz

Environmental Mic Response (PFM R31 Only)

NO TONE MODIFICATION

Max. SSPL90: 134.8 dB at 500 Hz
 HF Avg SSPL90: 126.4 dB
 HF Avg Full On Gain: 40.9 dB at 60 dB in
 Reference Test Gain: 40.8 dB
 Response Limit: 81.1 dB F1=200 Hz, F2=8 kHz
 Total Harmonic Dist: 1.1 % at 500 Hz
 1.1 % at 800 Hz
 0.3 % at 1600 Hz



Williams Sound Corp.

10321 West 70th St., Eden Prairie, MN 55344
U.S.A. 800-328-6190 / 952-943-2252 / FAX: 952-943-2174

www.williamssound.com

© 2003, Williams Sound Corp.

MAN 072C